

SPG 12V - 26Ah | VRLA GEL Battery

SPG are sealed valve-regulated lead acid recombinant batteries that are non-spillable and maintenance-free. Although initially more expensive to purchase than AGM they offer a lower total cost to own over the life of the battery. When it comes to performance and life span the SPG batteries outperform other technologies and provide the greatest value for your stand-by application or cycling needs.

Technical Features

- Micro millimeter SiO₂ and H₂SO₄ gelled electrolyte technology for efficient gas recombination of up to 99% and freedom from electrolyte maintenance or water adding.
- Not restricted for air transport-complies with IATA/ICAO Special Provision A67.
- UL-recognized component.
- Can be mounted in any orientation.
- Computer designed lead, calcium tin alloy grid for high power density.
- Long service life, float or cyclic applications.
- Maintenance-free operation.
- Low self discharge.
- Case and cover available in both standard and flame retardant ABS.

Specifications

Nominal Voltage	12 V		
Number of cells	6		
Design Life	12 years		
Dimensions	Length	166 mm	
	Width	175 mm	
	Height	125 mm	
	Total Height	125 mm	
Approx. Weight	7.9 kg		
Nominal Capacity (25°C)	20 hours rate (1.30 A, 10.5 V)	26.0 Ah	
	10 hours rate (2.32 A, 10.8 V)	23.2 Ah	
	5 hours rate (4.16 A, 10.5 V)	20.8 Ah	
	1 hour rate (15.60 A, 9.6 V)	15.6 Ah	
Max. Discharge Current (25°C)	390 A (5s)		
Short Circuit Current	1010 A		
Internal Resistance	12.5 mOhms		
Fully Charged battery (25°C)	390 A (5s)		
Self-Discharge	3% of capacity declined per month at 25°C (average)		
Operating Temperature Range	Discharge	:-15°C~50°C	
	Charge	:-10°C~50°C	
	Storage	:-20°C~50°C	
Max. Charging Current	7.8 A		
Charging Characteristics (25°C)	Float Charging Voltage	13.60 V to 13.80 V	
	Temperature compensation	-18 mV/°C	
	Cyclic Charging Voltage	14.40 V to 14.70 V	
	Temperature Compensation	-30 mV/°C	

Battery Construction

Component	Positive Plate	Negative Plate	Container	Cover	Safety Valve	Terminal	Separator	Electrolyte
Raw material	Lead dioxide	Lead	ABS	ABS	Rubber	Copper	Fiberglass	Gelled acid

Dimensions

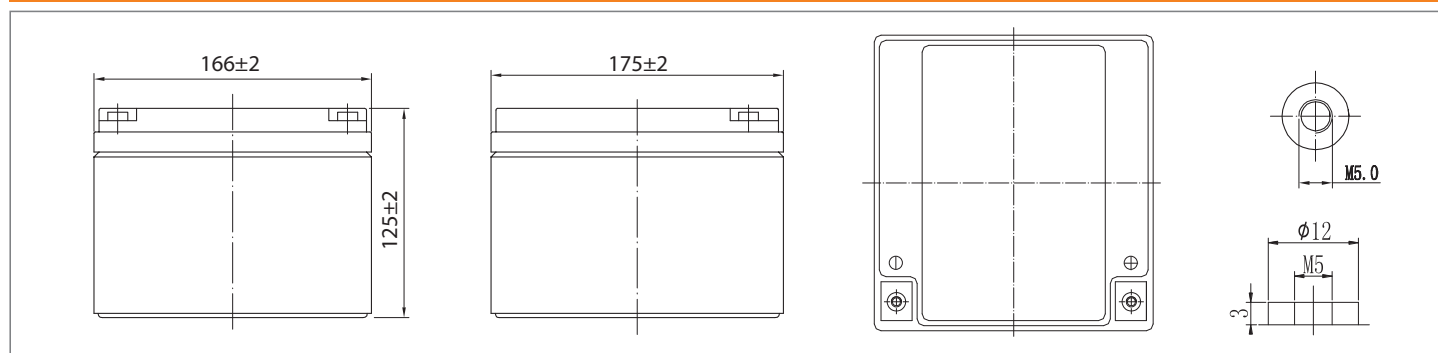

Constant Current Discharge (Amperes) at 25°C

End Voltage (Volts/Cell)	10min	15min	30min	1h	2h	3h	4h	5h	8h	10h	20h
1.60 V	53.3	44.2	26.0	15.6	8.97	6.36	5.17	4.24	2.84	2.40	1.32
1.65 V	51.7	43.1	25.5	15.4	8.92	6.33	5.14	4.22	2.82	2.39	1.31
1.70 V	49.6	41.5	24.7	15.0	8.84	6.28	5.11	4.19	2.80	2.38	1.31
1.75 V	47.4	40.1	24.1	14.7	8.71	6.24	5.07	4.16	2.78	2.37	1.30
1.80 V	44.8	38.0	23.2	14.2	8.49	6.05	4.92	4.04	2.70	2.32	1.27

Constant Power Discharge (Watts) at 25°C

End Voltage (Volts/Cell)	10min	15min	30min	1h	2h	3h	4h	5h	8h	10h	20h
1.60 V	601	504	298	181	105	75.6	61.6	50.7	34.1	28.8	15.8
1.65 V	583	492	292	178	104	75.2	61.2	50.4	33.9	28.7	15.8
1.70 V	559	474	283	173	103	74.7	60.8	50.0	33.6	28.6	15.7
1.75 V	535	458	276	170	102	74.1	60.4	49.7	33.4	28.4	15.6
1.80 V	505	433	266	165	99.3	71.9	58.6	48.2	32.4	27.8	15.3

Note: The above characteristics data can be obtained within three charge/discharge cycles.

SPG 12V - 26Ah | VRLA GEL Battery

Temperature Effects on Float Life

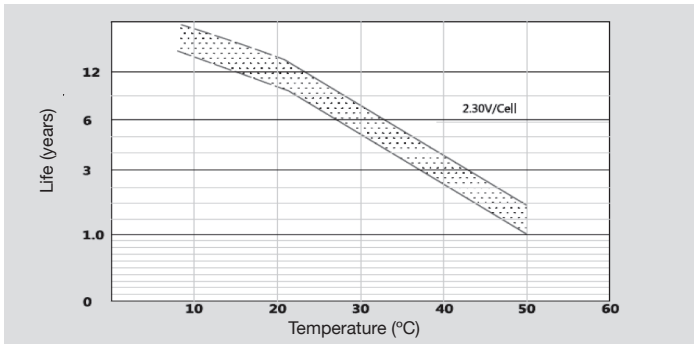

Self Discharge Characteristics

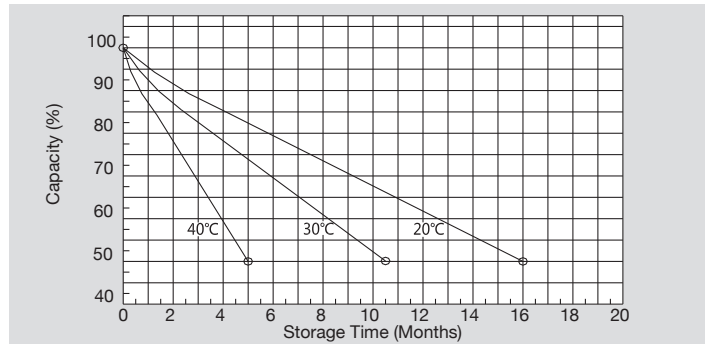

Discharge Characteristics (25°C)

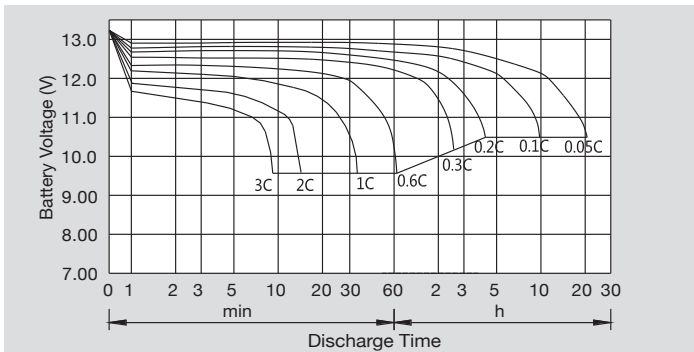

Charging Characteristics (25°C)

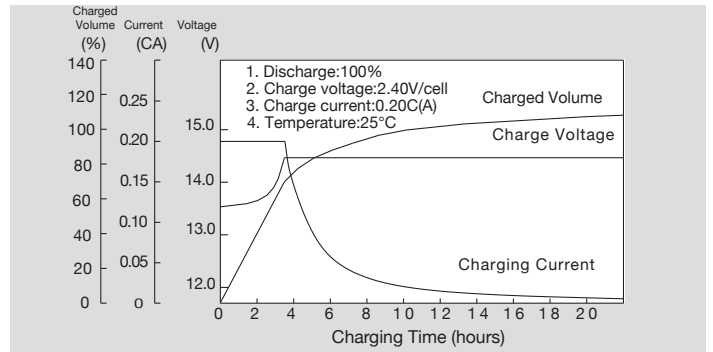

Relationship Between Charging Voltage and Temperature

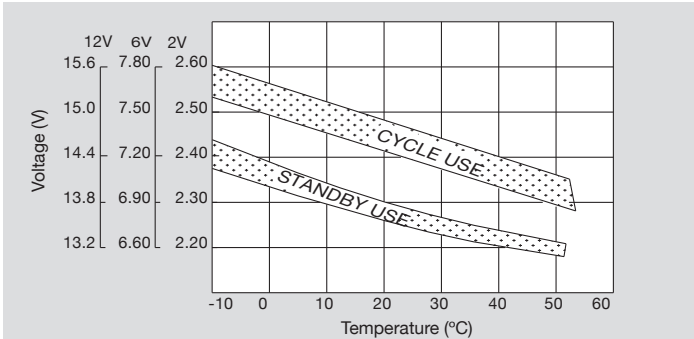

Relationship Between OCV and Residual Capacity (25°C)

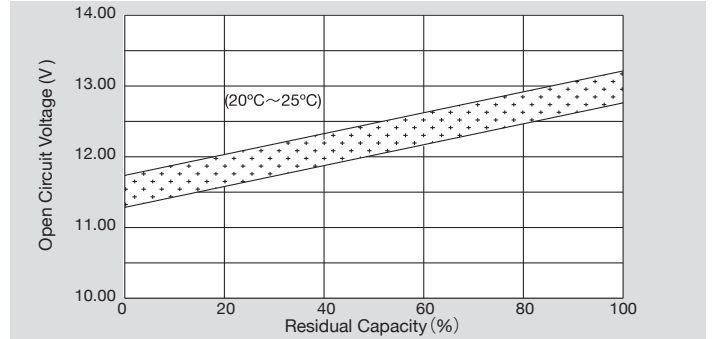

Cycle Service Life in Relation to Depth of Discharge

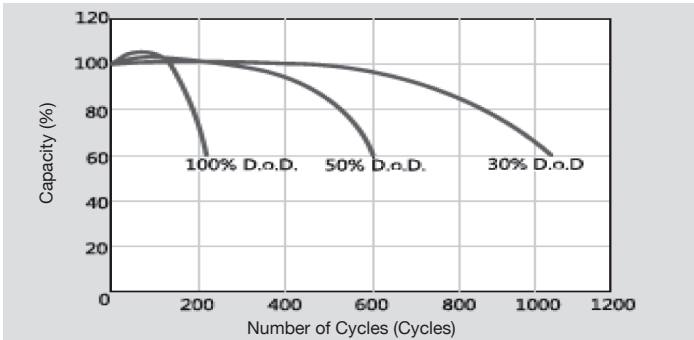

Temperature Effects on Capacity

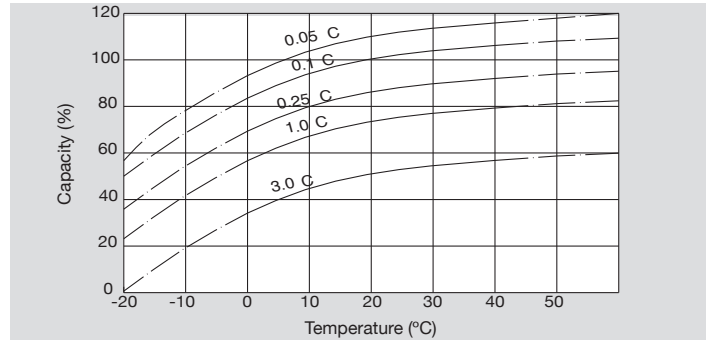

SYSTEMS SUNLIGHT S.A.

Headquarters

2 Ermou & Nikis Str., Syntagma Sq.
 105 63 Athens, Attica, Greece
T +30 210 6245400 F +30 210 6245409
European Manufacturing Plant
 672 00 Neo Olvio, Xanthi, Greece
T +30 25410 48100 F +30 25410 95446

Global Service Department

366 Tatoiou Str.
 136 73 Acharnes, Attica, Greece
T +30 210 6245600 F +30 210 6245619

