

SPG 12V - 100Ah | VRLA GEL Battery

SPG are sealed valve-regulated lead acid recombinant batteries that are non-spillable and maintenance-free. Although initially more expensive to purchase than AGM they offer a lower total cost to own over the life of the battery. When it comes to performance and life span the SPG batteries outperform other technologies and provide the greatest value for your stand-by application or cycling needs.

Technical Features

- Micro millimeter SiO₂ and H₂SO₄ gelled electrolyte technology for efficient gas recombination of up to 99% and freedom from electrolyte maintenance or water adding.
- Not restricted for air transport-complies with IATA/ICAO Special Provision A67.
- UL-recognized component.
- Can be mounted in any orientation.
- Computer designed lead, calcium tin alloy grid for high power density.
- Long service life, float or cyclic applications.
- Maintenance-free operation.
- Low self discharge.
- Case and cover available in both standard and flame retardant ABS.

Specifications

Nominal Voltage	12 V	
Number of cells	6	
Design Life	12 years	
Dimensions	Length	330 mm
	Width	171 mm
	Height	215 mm
	Total Height	222 mm
Approx. Weight	32 kg	
Nominal Capacity (25°C)	20 hours rate (5.3 A, 10.5 V)	106.0 Ah
	10 hours rate (10.3 A, 10.5 V)	103.0 Ah
	5 hours rate (17.5 A, 10.5 V)	87.5 Ah
	1 hour rate (66.2 A, 9.6 V)	66.2 Ah
Max. Discharge Current (25°C)	900 A (5s)	
Short Circuit Current	2100 A	
Internal Resistance	4.5 mOhms	
Fully Charged battery (25°C)		
Self-Discharge	3% of capacity declined per month at 20°C (average)	
Operating Temperature Range	Discharge	-20~60°C
	Charge	-10~60°C
	Storage	-20~60°C
Charge Methods:	Standby use:	No charging current limit is required
	Charging voltage:	13.38-13.68 Volts
	Cyclic use: Maximum charging current:	
	Charging voltage:	14.28-14.52 Volts
	Temperature compensation:	stand by -20 mV/°C; cyclic use -30 mV/°C
Constant Voltage Charge (25°C)	30% of rated capacity	

Battery Construction

Component	Positive Plate	Negative Plate	Container	Cover	Safety Valve	Terminal	Separator	Electrolyte
Raw material	Lead dioxide	Lead	ABS	ABS	Rubber	Copper	Fiberglass	Gelled acid

Dimensions

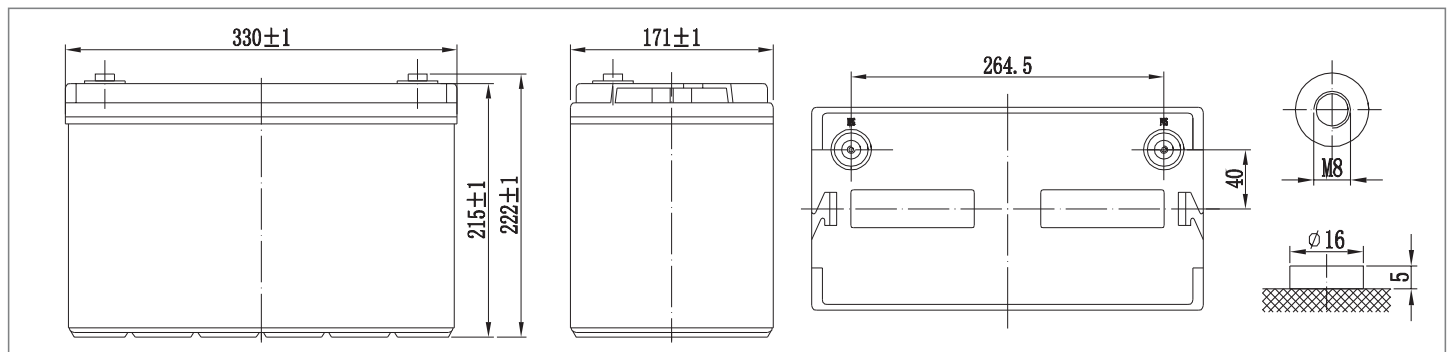

Constant Current Discharge (Amperes) at 25°C

End Voltage (Volts/Cell)	5min	10min	15min	30min	45min	1h	3h	5h	10h
1.60 V	314	229	185	108.0	80.5	66.2	27.9	19.0	10.8
1.65 V	296	221	178	104.0	78.7	62.5	27.7	18.3	10.6
1.70 V	270	200	164	96.0	73.0	61.5	27.2	18.0	10.5
1.75 V	242	187	153	93.0	71.3	60.5	26.9	17.5	10.3
1.80 V	221	175	143	91.0	70.0	57.4	25.3	17.2	10.0

Constant Power Discharge (Watts/Cell) at 25°C

End Voltage (Volts/Cell)	5min	10min	15min	30min	45min	1h	2h	3h	5h
1.60 V	547	392	321	199	150	124	70.6	52.8	35.8
1.65 V	517	379	315	188	146	118	67.8	51.2	35.4
1.70 V	478	360	299	183	137	114	66.8	50.9	35.0
1.75 V	441	353	294	177	134	111	64.5	49.1	34.4
1.80 V	415	329	279	171	131	104	62.5	48.5	34.0

SPG 12V - 100Ah | VRLA GEL Battery

Temperature Effects on Float Life

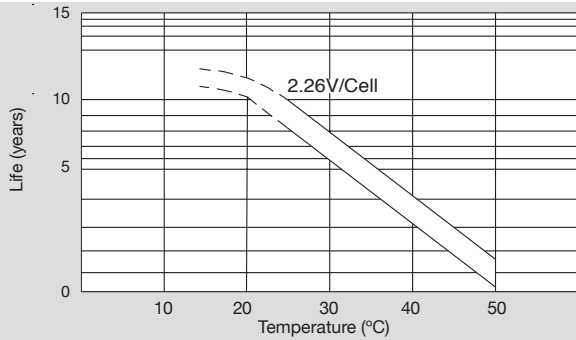

Self Discharge Characteristics

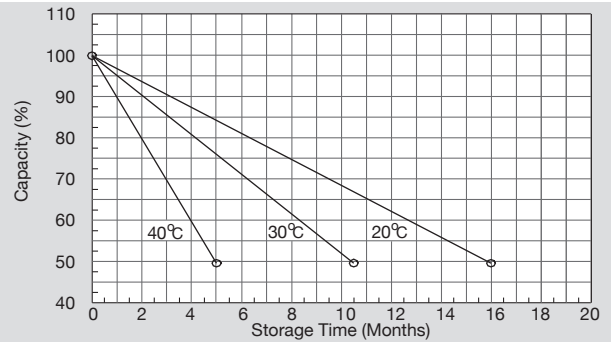

Discharge Characteristics (25°C)

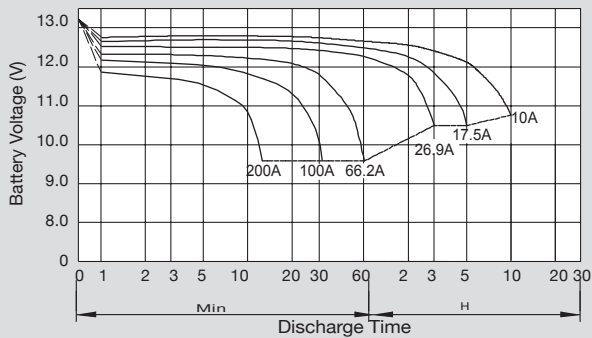

Constant Voltage Charging Characteristic (0.25 CA, 25°C)

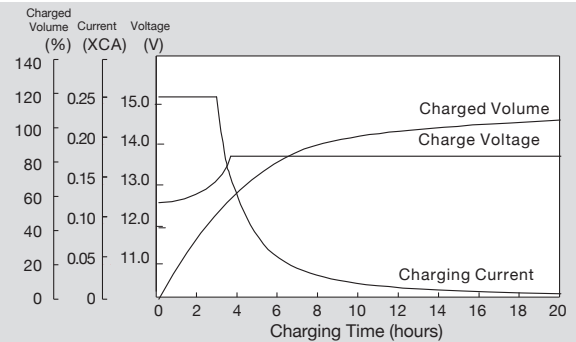

Relationship Between Charging Voltage and Temperature

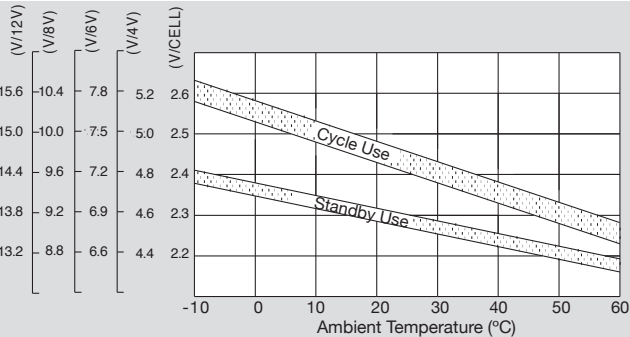

Relationship of OCV and State of Charge (25°C)

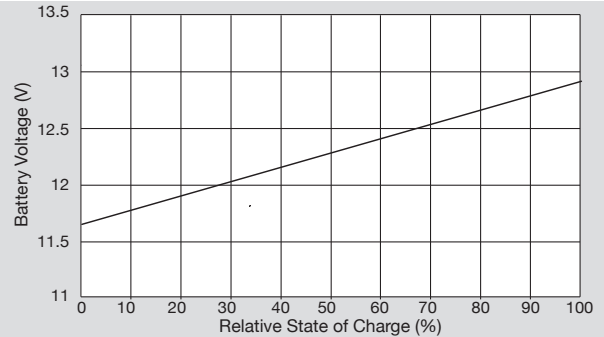

Cycle Service Life in Relation to Depth of Discharge

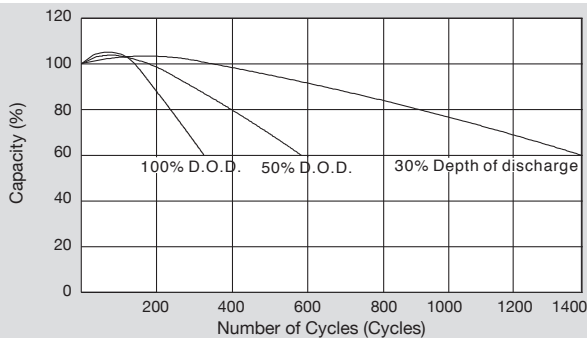

Temperature Effects on Capacity

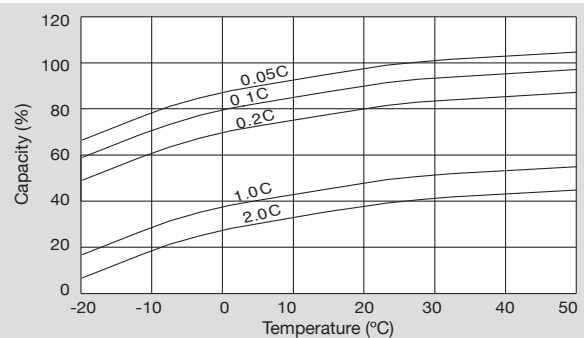

SYSTEMS SUNLIGHT S.A.

Headquarters

2 Ermou & Nikis Str., Syntagma Sq.
105 63 Athens, Attica, Greece

T +30 210 6245400 F +30 210 6245409

European Manufacturing Plant

672 00 Neo Olvio, Xanthi, Greece

T +30 25410 48100 F +30 25410 95446

Global Service Department

366 Tatoiou Str.

136 73 Acharnes, Attica, Greece

T +30 210 6245600 F +30 210 6245619

