

AccuForce 12V - 120Ah | VRLA Battery



Applications

- Uninterruptible Power Supplies (UPS)
- Electric Power Systems (EPS)
- Emergency backup power supplies
- Electronic apparatus and equipment
- Communication power supplies
- DC power supplies
- Auto control system

Specifications

Nominal Voltage	12 V		
Number of cells	6		
Design Life	10 years		
Dimensions	Length	409 mm	
	Width	176 mm	
	Height	225 mm	
	Total Height	225 mm	
Approx. Weight	33.5 kg		
		20 hours rate (6.3 A, 10.8 V)	126.0 Ah
Nominal Capacity (25°C)		10 hours rate (12.0 A, 10.8 V)	120.0 Ah
		5 hours rate (21.0 A, 10.5 V)	105.0 Ah
		1 hour rate (74.4 A, 9.6 V)	74.4 Ah
Max. Discharge Current (25°C)	960 A (5s)		
Internal Resistance	4.0 mOhms		
Fully Charged battery (25°C)			
Self-Discharge	3% of capacity declined per month at 20°C (average)		
	Discharge	:-15°C~50°C	
	Charge	:-10°C~50°C	
Operating Temperature Range	Storage : -20°C~50°C		
Short Circuit Current	3215 A		
		Cycle use	2.40-2.45 Vpc
Charge Methods:	Maximum charging current 36 A		
	Temperature compensation -30 mV/°C		
	Standby use 2.23-2.27 Vpc		
	Temperature compensation -18 mV/°C		

Battery Construction

Component	Positive Plate	Negative Plate	Container	Cover	Safety Valve	Terminal	Separator	Electrolyte
Raw material	Lead dioxide	Lead	ABS	ABS	Rubber	Copper	Fiberglass	Sulfuric acid

Dimensions

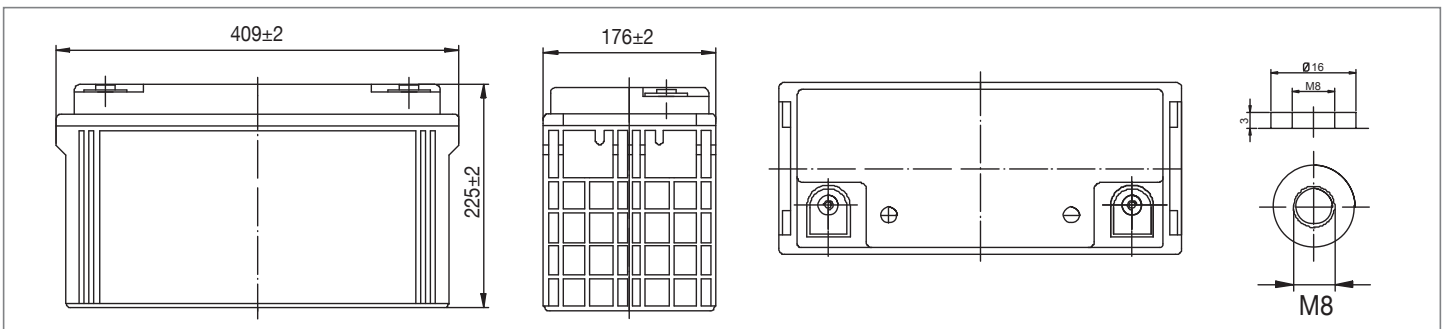

Constant Current Discharge (Amperes) at 25°C

End Voltage (Volts/Cell)	10min	15min	30min	1h	2h	3h	4h	5h	6h	8h	10h	20h
1.60 V	236	198	120	74.4	43.8	30.6	25.1	21.4	18.7	14.7	12.2	6.41
1.65 V	229	193	118	73.3	43.6	30.4	24.9	21.3	18.6	14.6	12.2	6.40
1.70 V	220	186	114	71.4	43.2	30.2	24.8	21.1	18.5	14.5	12.2	6.38
1.75 V	210	180	111	70.0	42.6	30.0	24.6	21.0	18.4	14.4	12.1	6.34
1.80 V	198	170	107	67.9	41.5	29.1	23.9	20.4	17.8	14.0	12.0	6.30

Constant Power Discharge (Watts) at 25°C

End Voltage (Volts/Cell)	10min	15min	30min	1h	2h	3h	4h	5h	6h	8h	10h	20h
1.60 V	2552	2174	1346	848	508	360	295	253	221	174	146	77.0
1.65 V	2475	2122	1319	835	505	358	293	252	220	173	146	76.8
1.70 V	2373	2044	1279	814	500	355	291	250	219	172	145	76.6
1.75 V	2271	1974	1248	798	493	353	289	248	217	171	144	76.1
1.80 V	2144	1870	1202	774	480	342	281	241	211	166	143	75.6

(Note) The above characteristics data are average values obtained within three charge/discharge cycles not the minimum values.

AccuForce 12V - 120Ah | VRLA Battery

Temperature Effects on Float Life

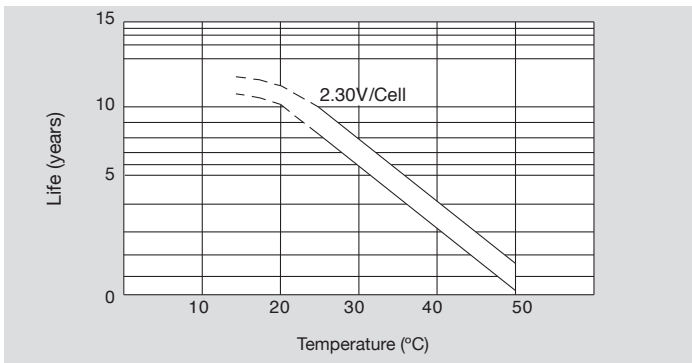

Self Discharge Characteristics

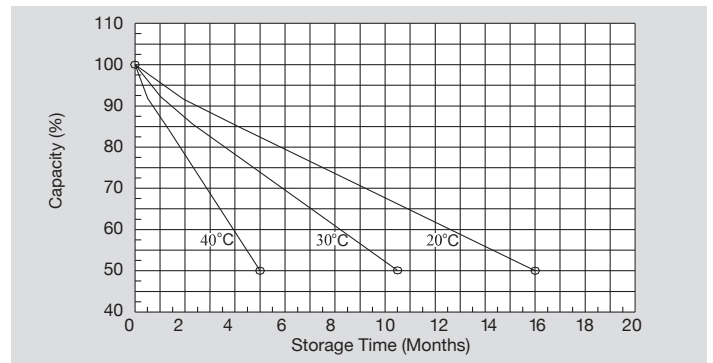

Discharge Characteristics (25°C)

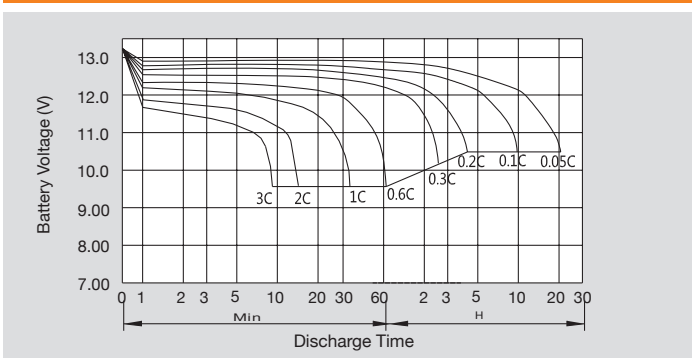

Constant Voltage Charging Characteristic (0.25 CA, 25°C)

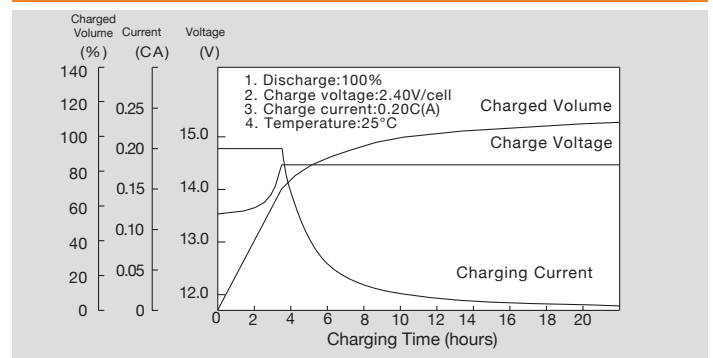

Relationship Between Charging Voltage and Temperature

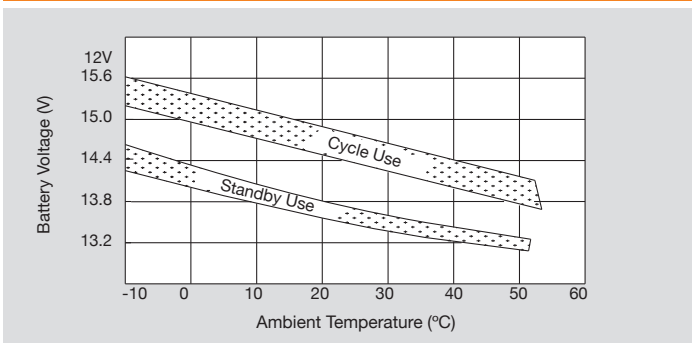

Relationship Between OCV and Residual Capacity (25°C)

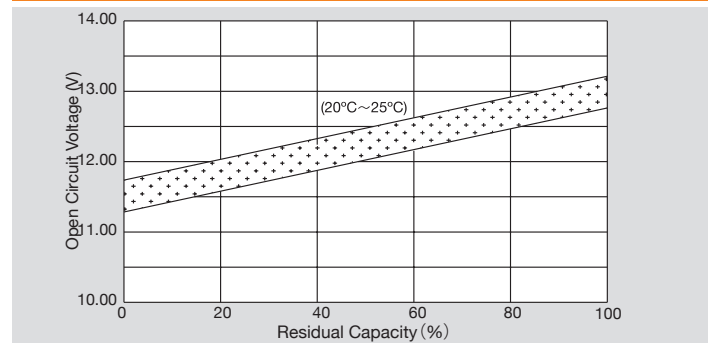

Cycle Service Life in Relation to Depth of Discharge

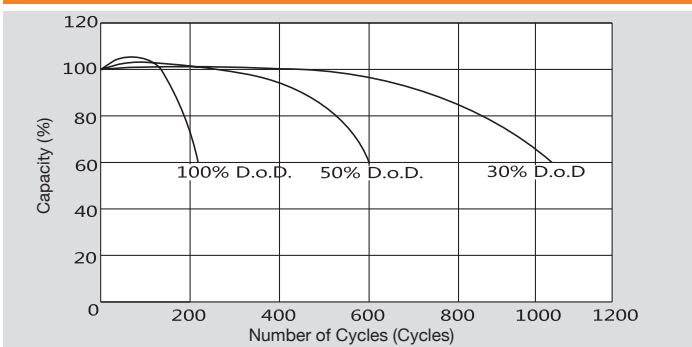

Temperature Effects on Capacity

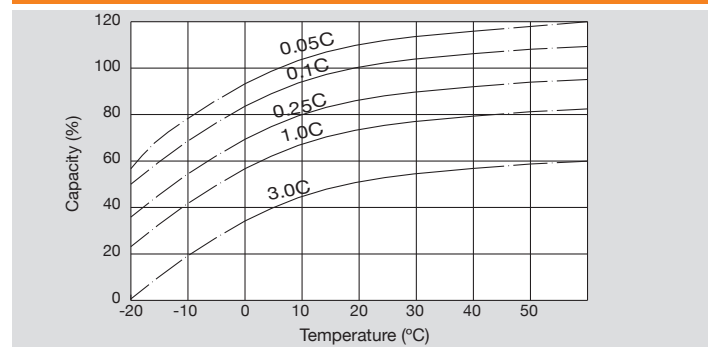

SYSTEMS SUNLIGHT S.A.

Headquarters

2 Ermou & Nikis Str., Syntagma Sq.
105 63 Athens, Attica, Greece

T +30 210 6245400 F +30 210 6245409

European Manufacturing Plant

672 00 Neo Olvio, Xanthi, Greece

T +30 25410 48100 F +30 25410 95446

Global Service Department

90 Tatoiou Str.

136 73 Acharnes, Attica, Greece

T +30 210 6245600 F +30 210 6245619

